

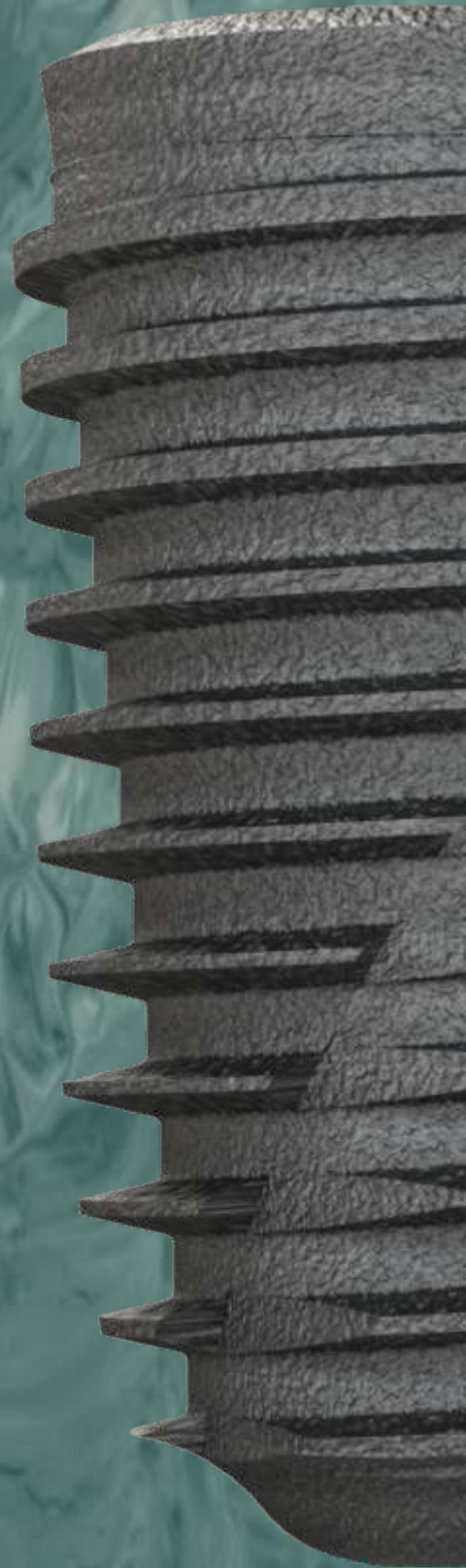

PRIVE

DENTAL IMPLANT TECHNOLOGIES



Digital Library



Made In Germany



www.priveimplant.com



CONTENTS

Prive Implant SEM Surface Images	4
Prive Implant	5
Healing Caps & Straight Abutment	6
Angled Abutment	7
Abutment & Prosthetic Application Scheme	8
Locator Abutment & Components	9
Ball Abutment & Components	10
Analogs & Transfer Post & Premill & Temporary Abutment	11
Multi Unit Abutment Scheme	12
Multi Unit Abutment Components	13
Smart Base Abutment Groups	14
Digital Part Scheme	15
Surgical Kit	16



PRIVE IMPLANT

Product Code	Diameter (mm)	Height (mm)	
FRP3308-T	ø 3.3	8	
FRP3310-T		10	
FRP3311-T		11.5	
FRP3313-T		13	
FRP3315-T		15	

Product Code	Diameter (mm)	Height (mm)	
FRP3507-T	ø 3.5	7	
FRP3508-T		8	
FRP3510-T		10	
FRP3511-T		11.5	
FRP3513-T		13	
FRP3515-T		15	

Product Code	Diameter (mm)	Height (mm)	
FRP3707-T	ø 3.7	7	
FRP3708-T		8	
FRP3710-T		10	
FRP3711-T		11.5	
FRP3713-T		13	
FRP3715-T		15	

Product Code	Diameter (mm)	Height (mm)	
FRP4007-T	ø 4.0	7	
FRP4008-T		8	
FRP4010-T		10	
FRP4011-T		11.5	
FRP4013-T		13	
FRP4015-T		15	

Product Code	Diameter (mm)	Height (mm)	
FRP4307-T	ø 4.3	7	
FRP4308-T		8	
FRP4310-T		10	
FRP4311-T		11.5	
FRP4313-T		13	
FRP4315-T		15	

Product Code	Diameter (mm)	Height (mm)	
FRP4507-T	ø 4.5	7	
FRP4508-T		8	
FRP4510-T		10	
FRP4511-T		11.5	
FRP4513-T		13	
FRP4515-T		15	

Product Code	Diameter (mm)	Height (mm)	
FRP4807-T	ø 4.8	7	
FRP4808-T		8	
FRP4810-T		10	
FRP4811-T		11.5	
FRP4813-T		13	
FRP4815-T		15	

Product Code	Diameter (mm)	Height (mm)	
FRP5007-T	ø 5.0	7	
FRP5008-T		8	
FRP5010-T		10	
FRP5011-T		11.5	
FRP5013-T		13	
FRP5015-T		15	

* All products on this page manufactured using Titanium Grade4 (ISO5832-2)



HEALING CAPS & STRAIGHT ABUTMENT

Product Code	Diameter (mm)	Height (GH mm)
FNC401	ø 4.0	1
FNC402		2
FNC403		3
FNC404		4
FNC405		5
FNC406		6



Product Code	Diameter (mm)	Height (GH mm)
FNC4001	ø 4.0	1
FNC4002		2
FNC4003		3
FNC4004		4
FNC4005		5
FNC4006		6



Product Code	Diameter (mm)	Height (GH mm)
FNC501	ø 5.0	1
FNC502		2
FNC503		3
FNC504		4
FNC505		5
FNC506		6



Product Code	Diameter (mm)	Height (GH mm)
FNC5001	ø 5.0	1
FNC5002		2
FNC5003		3
FNC5004		4
FNC5005		5
FNC5006		6



Product Code	Diameter (mm)	Height (GH mm)
FNC601	ø 6.0	1
FNC602		2
FNC603		3
FNC604		4
FNC605		5
FNC606		6



Product Code	Diameter (mm)	Height (GH mm)
FRP6001	ø 6.0	1
FRP6002		2
FRP6003		3
FRP6004		4
FRP6005		5
FRP6006		6



Cover Screw

Product Code	Diameter (mm)	Height (mm)
FRV3518	ø 3.3	5



* All products on this page manufactured using Titanium Grade23 (ISO5832-3)



ANGLED ABUTMENT

15 °

Product Code	Diameter (mm)	Height (GH mm)
FNC4115	ø 4.0	1
FNC4215		2
FNC4315		3
FNC4415		4
FNC4515		5



25 °

Product Code	Diameter (mm)	Height (GH mm)
FNC4125	ø 4.0	1
FNC4225		2
FNC4325		3
FNC4425		4
FNC4525		5



15 °

Product Code	Diameter (mm)	Height (GH mm)
FNC5115	ø 5.0	1
FNC5215		2
FNC5315		3
FNC5415		4
FNC5515		5



25 °

Product Code	Diameter (mm)	Height (GH mm)
FNC5125	ø 5.0	1
FNC5225		2
FNC5325		3
FNC5425		4
FNC5525		5



15 °

Product Code	Diameter (mm)	Height (GH mm)
FNC6115	ø 6.0	1
FNC6215		2
FNC6315		3
FNC6415		4
FNC6515		5



25 °

Product Code	Diameter (mm)	Height (GH mm)
FNC6125	ø 6.0	1
FNC6225		2
FNC6325		3
FNC6425		4
FNC6525		5



* All products on this page manufactured using Titanium Grade23 (ISO5832-3)



ABUTMENT & PROSTHETIC APPLICATION SCHEME

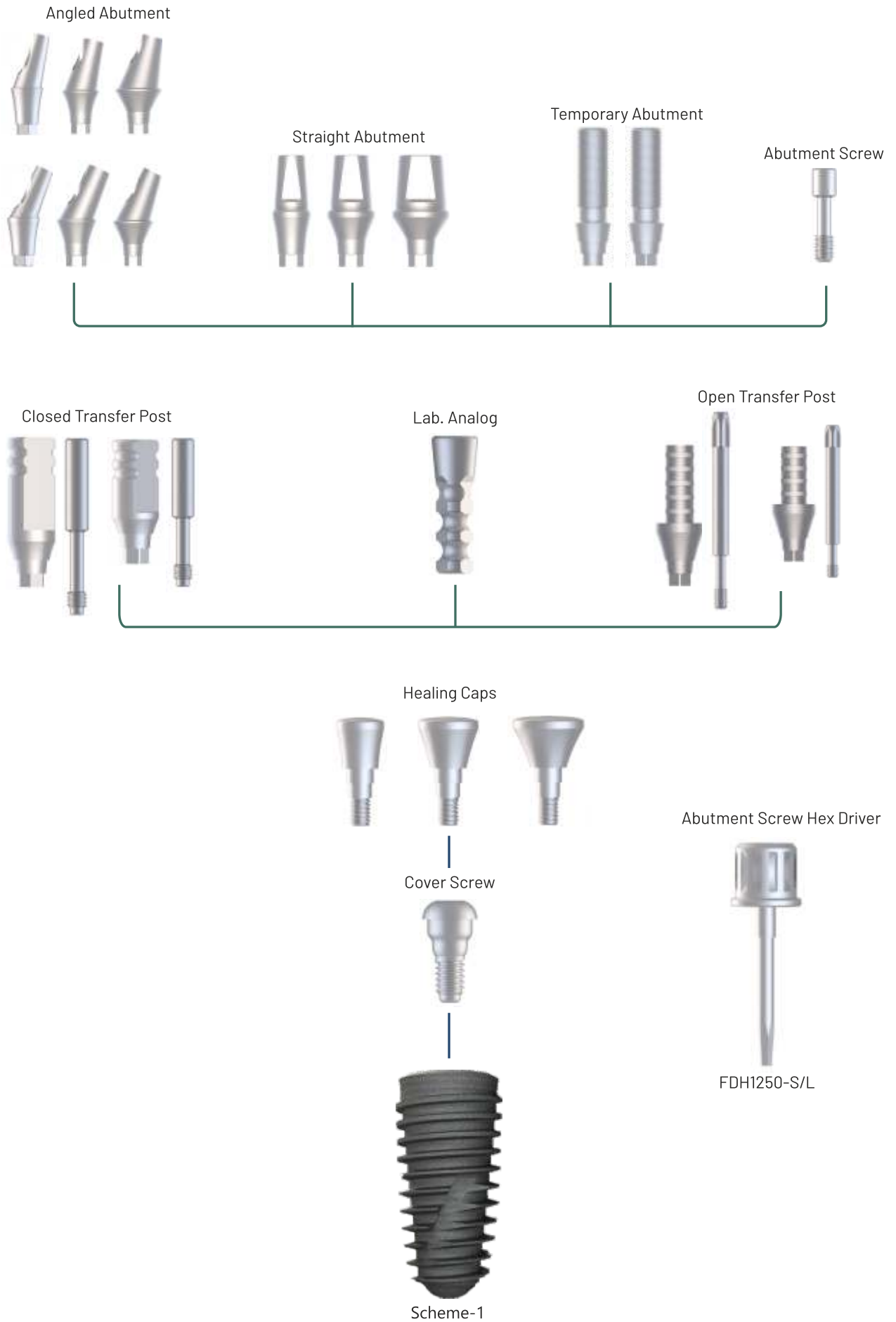



LOCATOR ABUTMENT & COMPONENTS

Locator Abutment

Product Code	Diameter (mm)	Height (GH mm)
FRCL3501	ø 3.7	1
FRCL3502		2
FRCL3503		3
FRCL3504		4
FRCL3505		5
FRCL3506		6



* Raw material Titanium Grade23 (ISO5832-3)

Locator Abutment Cap

Product Code	Diameter (mm)	Height (mm)
FRLC5523	ø 5.7	2.5



* Raw material Titanium Grade23 (ISO5832-3)

Locator Nylon Cap

Product Code	Diameter (mm)	Color
FRLC5520	ø 2.5	Gray
FRLC5521		Yellow
FRLC5522		Pink



* Raw material Nylon

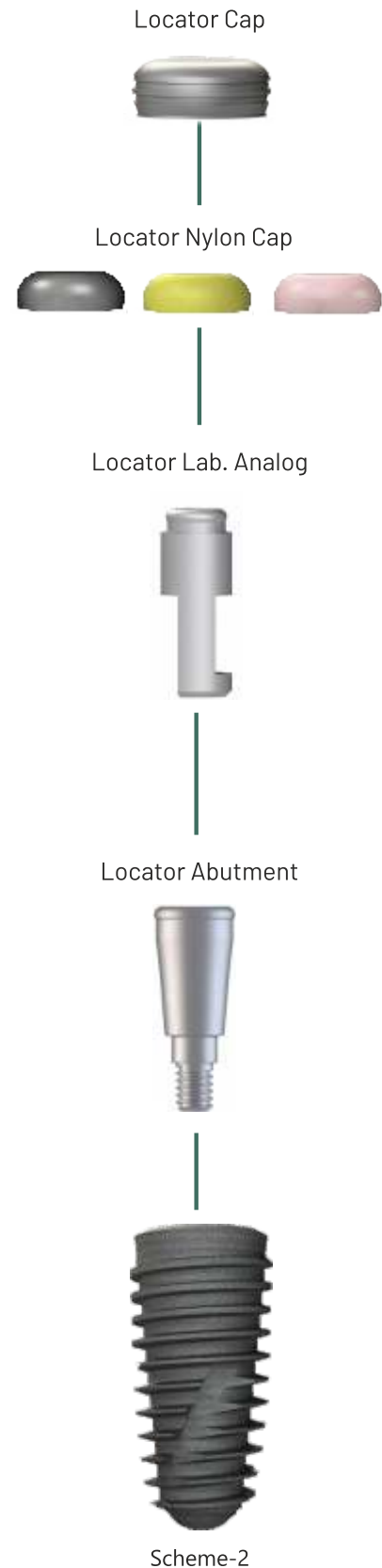



BALL ABUTMENT & COMPONENTS

Ball Abutment

Product Code	Diameter (mm)	Height (mm)
FRB3501	ø 4.5	1
FRB3502		2
FRB3503		3
FRB3504		4
FRB3505		5



* Raw material Titanium Grade23 (ISO5832-3)

Ball Abutment Cap

Product Code	Diameter (mm)	Height (mm)
FBC5025	ø 4.5	3.9



* Raw material Titanium Grade23 (ISO5832-3)

Ball Abutment Cap

Product Code	Color	Height (mm)
FRC5020	Transparent	3.5



* Raw material Nylon

Ball Abutment Cap

Product Code	Diameter (mm)	Height (mm)
FRBC5030	ø 4.5	2.0



* Raw material Titanium Grade23 (ISO5832-3)

Ball Abutment Cap

Product Code	Diameter (mm)	Height (mm)
FRB5045	ø 2.5	1.0

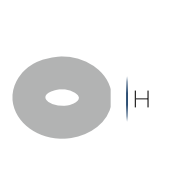

* Raw material Nylon

Ball Abutment Cap



Ball Abutment Cap



Ball Abutment



Ball Attachment Lab. Analog



Ball Abutment



Scheme-3

Lab. Analog

Product Code	Diameter (mm)	Height (mm)	
FNCL3018	∅ 4.7	14	

Digital Analog

Product Code	Diameter (mm)	Height (mm)	
FNCL3018	4.7	14	
FSR16M	M1.6	4.7	

Locator Lab. Analog

Product Code	Diameter (mm)	Height (mm)	
FRCL3555	∅ 4.7	14	

Ball Attachment Analog

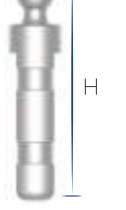
Product Code	Diameter (mm)	Height (mm)	
FV3550	∅ 3.5	14	

Closed Transfer Post

Product Code	Diameter (mm)	Height (mm)	
FNC300-S	∅ 4.5	12	
FNC300-L		14	
FNC300-SV	M1.8	14	
FNC300-LV		16	

Premill Abutment

Product Code	Diameter (mm)	Height (mm)	
FPM2300	∅ 14	23	

Open Transfer Post

Product Code	Diameter (mm)	Height (mm)	
FNC2318-S	∅ 4.5	12	
FNC2318-L		15	
FNC2018-S	M1.8	19	
FNC2018-L		22	

Premill Abutment

Product Code	Diameter (mm)	Height (mm)	
FPM2310	∅ 10	23	

Non - Hex Temporary Abutment

Product Code	Diameter (mm)	Height (mm)	
FGA305	∅ 4.0	12	

Hex Temporary Abutment

Product Code	Diameter (mm)	Height (mm)	
FGA300	∅ 4.0	12	

Scan Body

Product Code	Diameter (mm)	Height (mm)	
FSB7001	∅ 4.5	12	

Abutment Screw

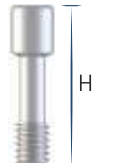
Product Code	Diameter (mm)	Height (mm)	
FSR180	M1.8	8.75	

* All products on this page manufactured using Titanium Grade23 (ISO5832-3)



MULTI UNIT ABUTMENT SCHEME

Multi Unit Abutment

Product Code	Diameter (mm)	Height (GH mm)
FCM5010	ø 4.7	1
FCM5020		2
FCM5030		3
FCM5040		4
FCM5050		5



Angled Multi Unit Abutment

Product Code	Diameter (mm)	Height (GH mm)
FMR1725	17°	2.5
FMR1735		3.5
FMR1745		4.5
FMR3035	30°	3.5
FMR3045		4.5

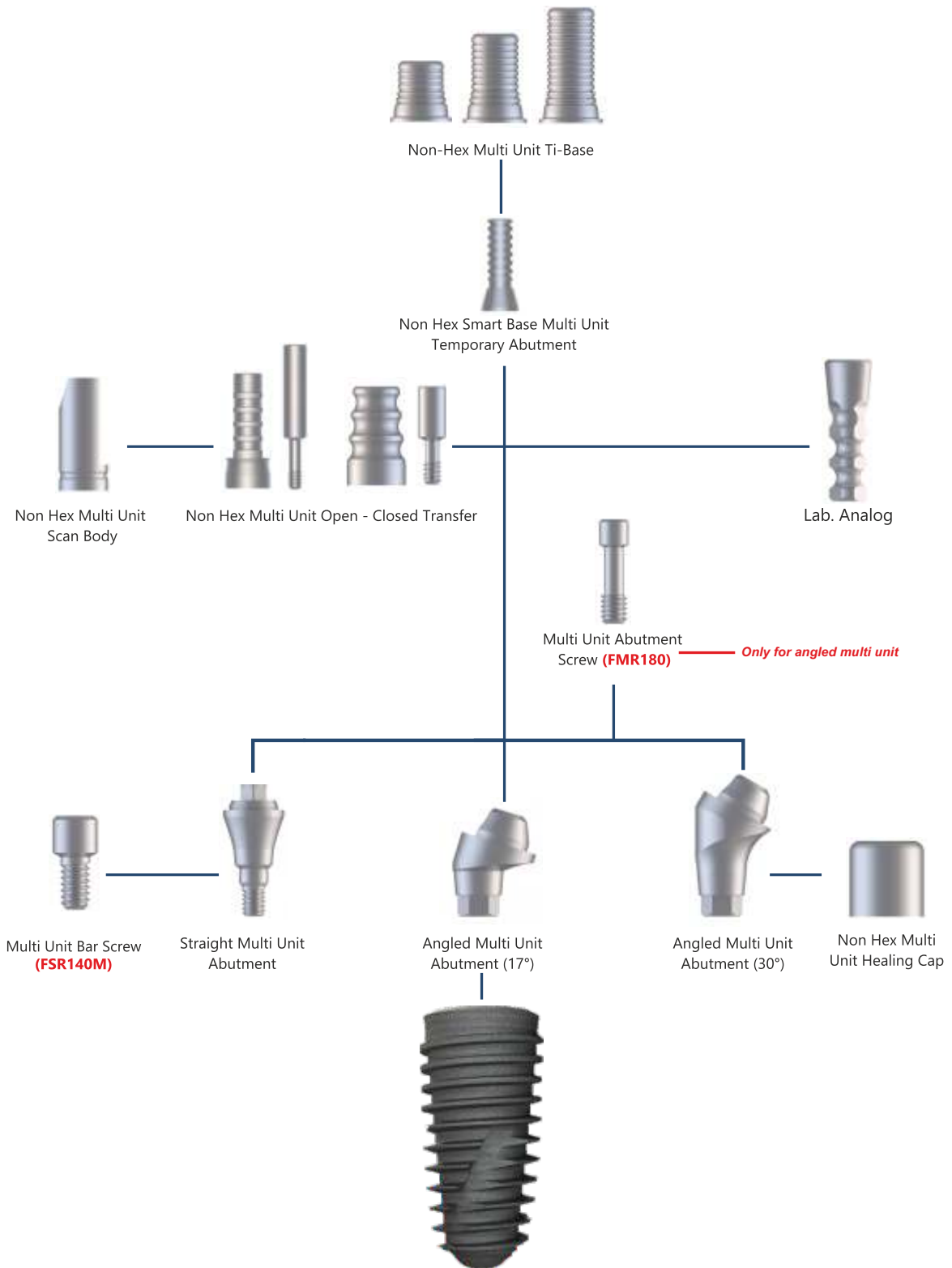
Scheme-4



MULTI UNIT ABUTMENT COMPONENTS

Multi Unit Lab. Analog

Product Code	Diameter (mm)	Height (mm)
FNCL3024	ø 4.7	14



Multi Unit Digital Analog

Product Code	Diameter (mm)	Height (mm)
FNCL3025	4.7	14
FSR16M	M1.6	5.0



Non-Hex Multi Unit Healing Cap

Product Code	Diameter (mm)	Height (mm)
FNCM202	ø 4.9	5



Non-Hex Multi Unit Scan Body

Product Code	Diameter (mm)	Height (mm)
FSB7030	ø 4.5	10

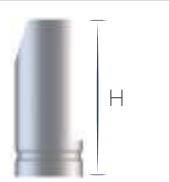

Non-Hex Multi Unit Temporary Abutment

Product Code	Diameter (mm)	Height (mm)
FNC3540M	ø 4.7	10



Non-Hex Multi Unit Ti-Base

Product Code	Diameter (mm)	Height (mm)
FKT3540M	ø 4.7	4.5
FKT3560M		6.5
FKT3580M		8.5



Multi Unit Ball Attachment

Product Code	Diameter (mm)	Height (mm)
FRBM5050	ø 4.7	2.5



Smart Base Non-Hex Casting Mold

Product Code	Diameter (mm)	Height (mm)
FNC3022M	ø 4.7	10



* Raw Material Nylon

Multi Unit Bar Screw

Product Code	Diameter (mm)	Height (mm)
FSR140M	M 1.4	4.5

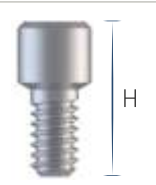

Non-Hex Multi Unit Open Transfer Post

Product Code	Diameter (mm)	Height (mm)
FM4300	ø 4.7	12
FV3014-L	M1.4	13



Non-Hex Multi Unit Closed Transfer Post

Product Code	Diameter (mm)	Height (mm)
FCT4780M	ø 4.7	8
FV3014-S	M1.4	8



* All products on this page manufactured using Titanium Grade23 (ISO5832-3)



SMART BASE ABUTMENT GROUPS

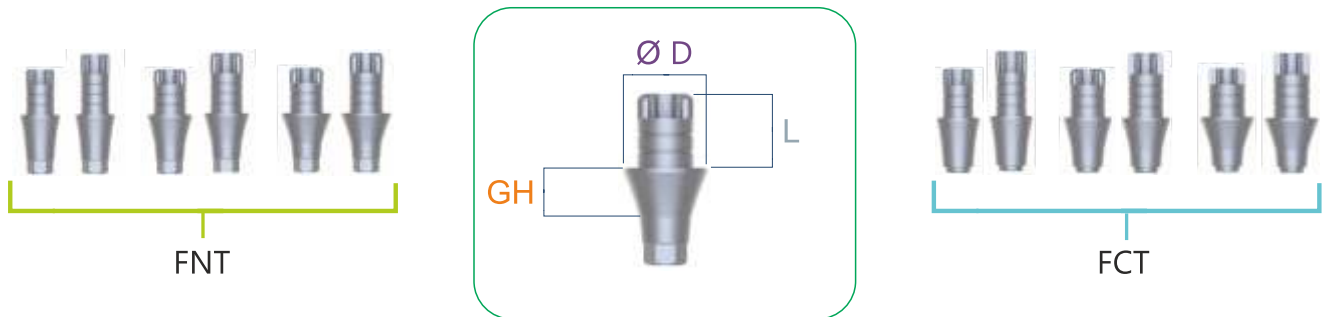

D	GH	L	TYPE	REF. CODE	TYPE	REF. CODE
Ø 4.0	1.0	4.5	Hex	FNT4001	Non-Hex	FCT4001
	2.0			FNT4002		FCT4002
	3.0			FNT4003		FCT4003
	4.0			FNT4004		FCT4004
	5.0			FNT4005		FCT4005
	1.0	6.0		FNT4061		FCT4061
	2.0			FNT4062		FCT4062
	3.0			FNT4063		FCT4063
	4.0			FNT4064		FCT4064
	5.0			FNT4065		FCT4065

Ø 4.5	1.0	4.5	Hex	FNT4501	Non-Hex	FCT4501
	2.0			FNT4502		FCT4502
	3.0			FNT4503		FCT4503
	4.0			FNT4504		FCT4504
	5.0			FNT4505		FCT4505
	1.0	6.0		FNT4561		FCT4561
	2.0			FNT4562		FCT4562
	3.0			FNT4563		FCT4563
	4.0			FNT4564		FCT4564
	5.0			FNT4565		FCT4565

Ø 5.0	1.0	4.5	Hex	FNT5001	Non-Hex	FCT5001
	2.0			FNT5002		FCT5002
	3.0			FNT5003		FCT5003
	4.0			FNT5004		FCT5004
	5.0			FNT5005		FCT5005
	1.0	6.0		FNT5061		FCT5061
	2.0			FNT5062		FCT5062
	3.0			FNT5063		FCT5063
	4.0			FNT5064		FCT5064
	5.0			FNT5065		FCT5065

* All products on this page manufactured using Titanium Grade23 (ISO5832-3)

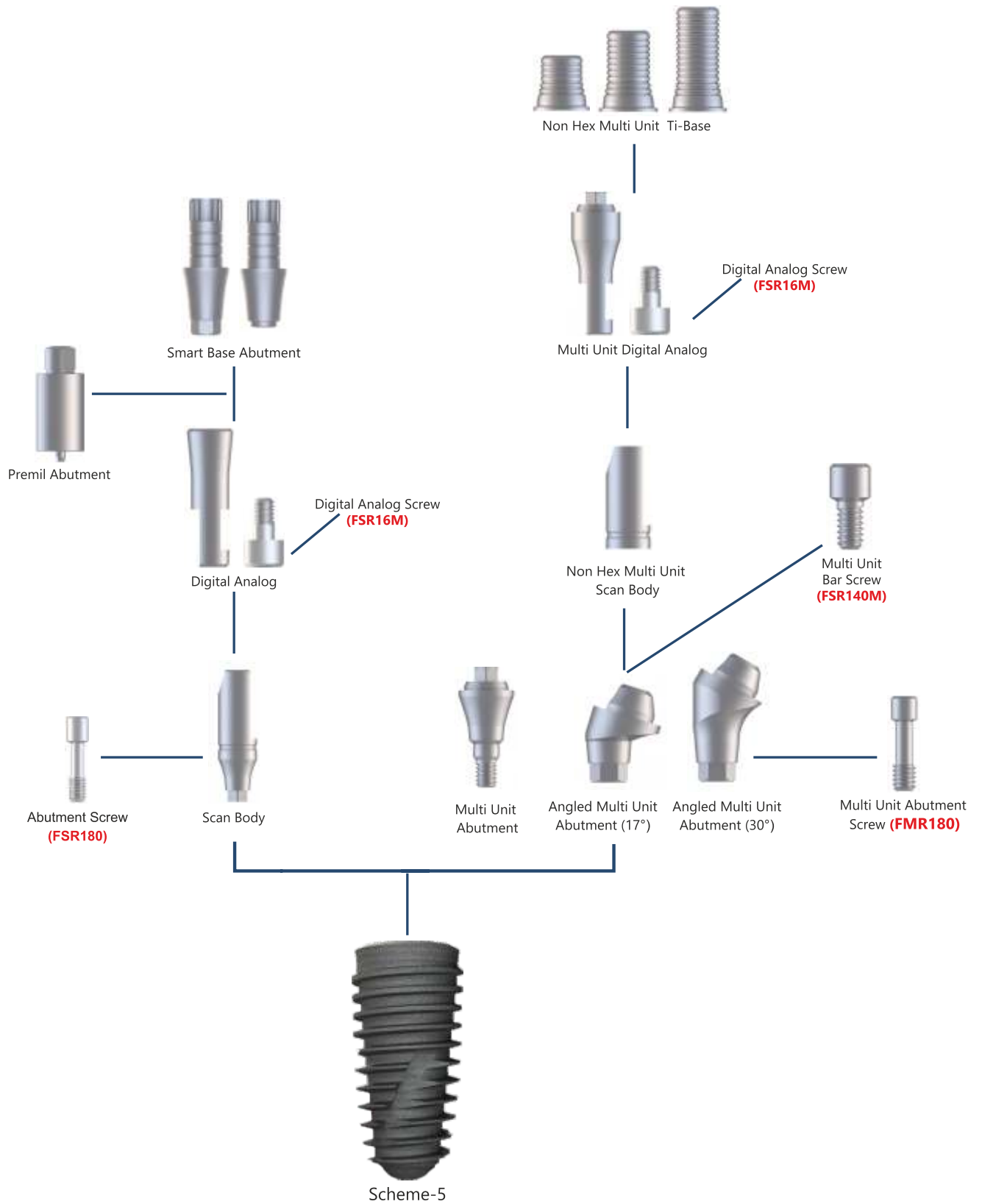

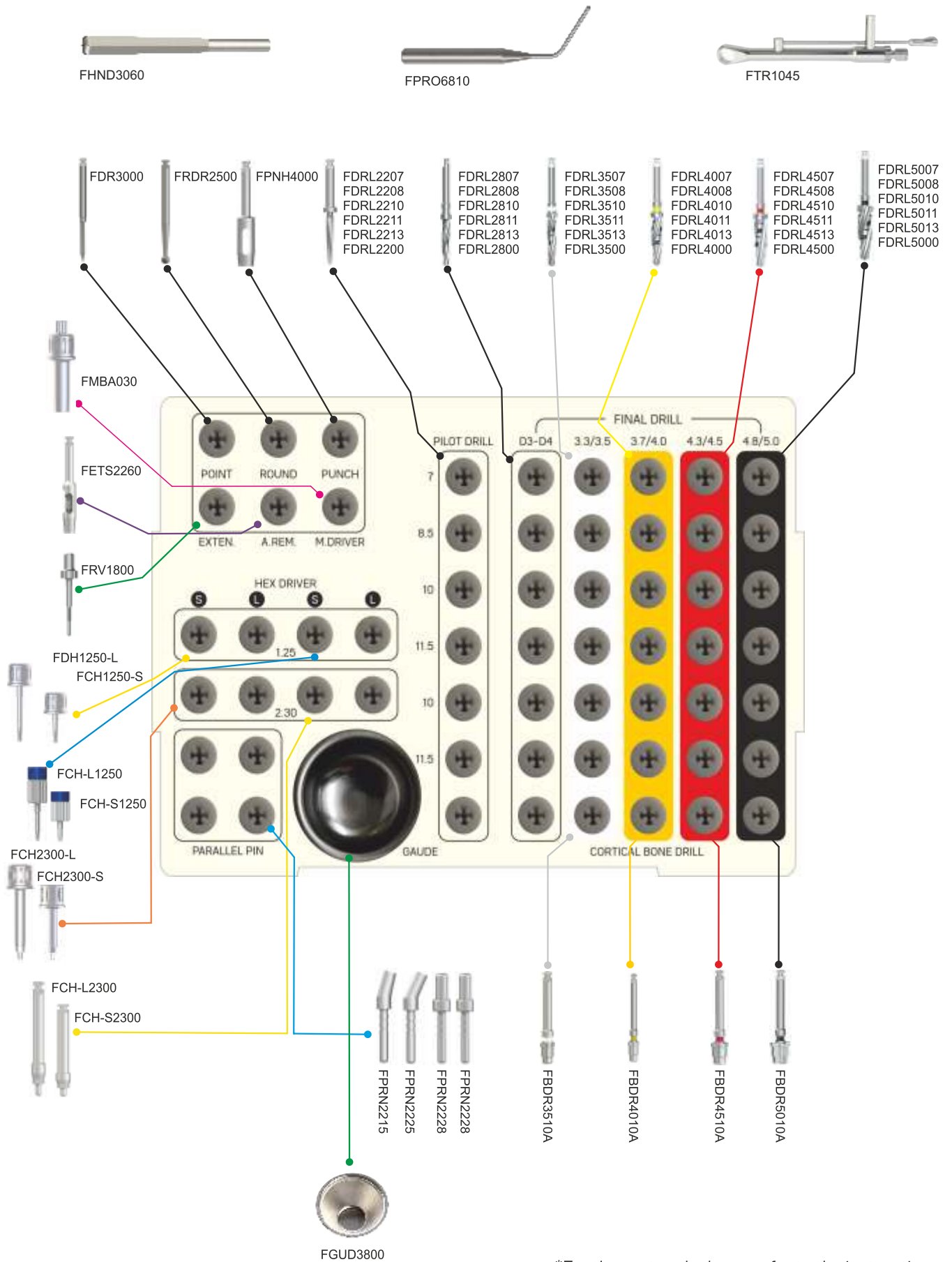

*For the protocol, please refer to the instructions for use included in the implant package.

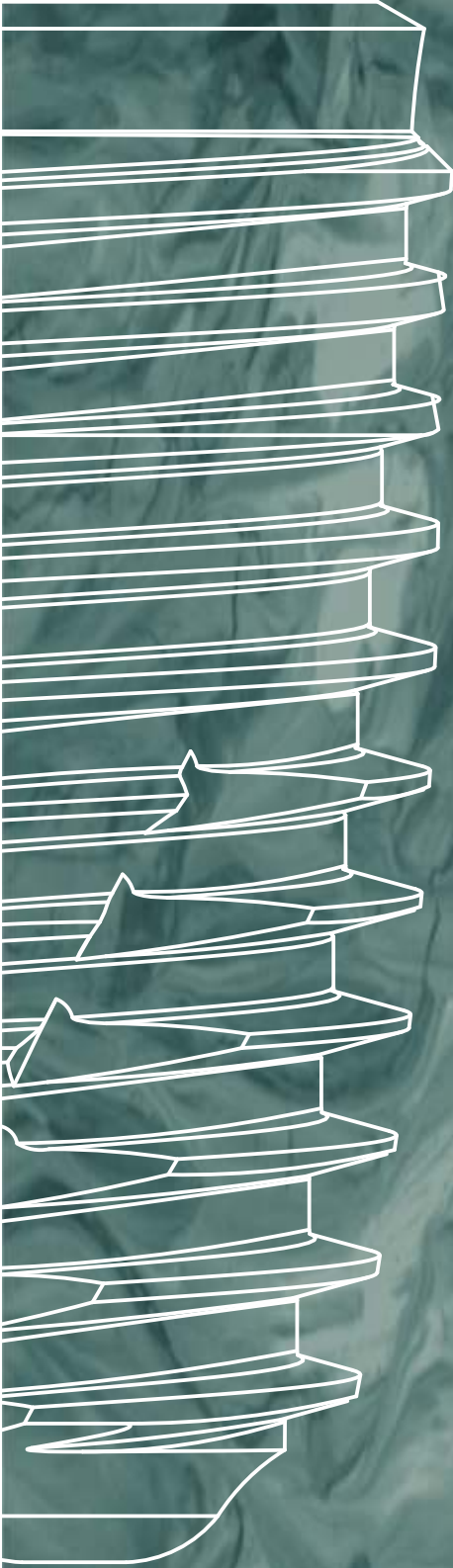

FOREVER MEDİKAL ve TEKNOLOJİ SAN. TİC. A.Ş.
Isarstraße 1, 83026 Rosenheim, Germany
Willy Rüsç-Straße 10/1 71394 Kernen im Remstal, Germany
+49 151 61696440
info@priveimplant.com

Gökevler Mh. 2331 Sk. No:1R Esenyurt - İstanbul - Türkiye
Tel: +90 212 852 04 00
info@forevermedikal.com



priveimplant